

596.596

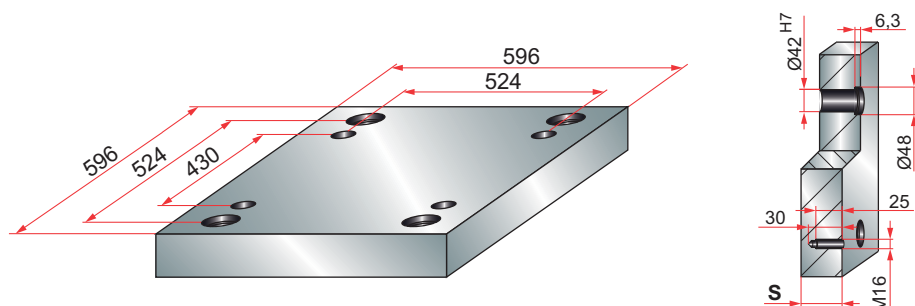

PBA

| PBA | |
|-----|----|
| S | 46 |
| | 56 |

mat.: 1.1730

PBA-EU

| PBA-EU | |
|--------|----|
| S | 46 |
| | 56 |

mat.: 1.1730

PBAS

| PBAS | |
|------|----|
| S | 46 |
| | 56 |

mat.: 1.1730

PBAS-EU

| PBAS-EU | |
|---------|----|
| S | 46 |
| | 56 |

mat.: 1.1730

PC

| S | Material | | | |
|-----|----------|--------|--------|--------|
| | 1.1730 | 1.2311 | 1.2312 | 1.2085 |
| 27 | * | * | * | o |
| 36 | * | * | * | o |
| 46 | * | * | * | o |
| 56 | * | * | * | o |
| 66 | * | * | * | o |
| 76 | * | * | * | o |
| 86 | | * | * | o |
| 96 | * | * | * | o |
| 116 | * | * | * | o |
| 136 | * | * | * | o |
| 156 | | * | * | o |

° Entrega 3/4 días - Delivery 3/4 days

PCX

| S | Material | | |
|-----|----------|--------|--------|
| | 1.2311 | 1.2312 | 1.2085 |
| 27 | * | * | o |
| 36 | * | * | o |
| 46 | * | * | o |
| 56 | * | * | o |
| 66 | * | * | o |
| 76 | * | * | o |
| 86 | * | * | o |
| 96 | * | * | o |
| 116 | * | * | o |
| 136 | * | * | o |
| 156 | * | * | o |

° Entrega 3/4 días - Delivery 3/4 days

596.596

PS

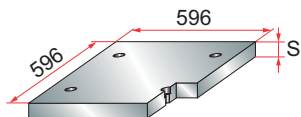

| PS | |
|----|----|
| S | 46 |
| | 56 |

mat.: 1.1730

PS-EU

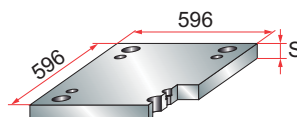

| PS-EU | |
|-------|----|
| S | 46 |
| | 56 |

mat.: 1.1730

ESP

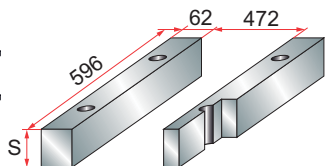

| ESP | |
|-----|-----|
| S | 76 |
| | 86 |
| | 96 |
| | 116 |
| | 136 |
| | 156 |

mat.: 1.1730

ESP-EU

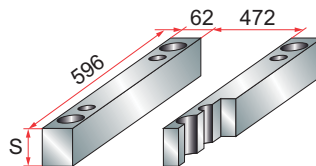

| ESP-EU | |
|--------|-----|
| S | 76 |
| | 86 |
| | 96 |
| | 116 |
| | 136 |
| | 156 |

mat.: 1.1730

CPE

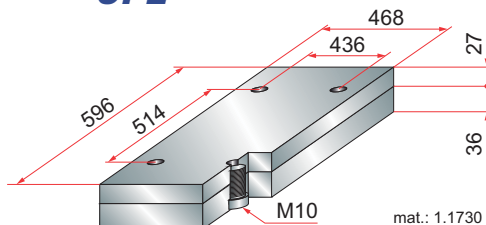

mat.: 1.1730

P PLATES

PBA-P

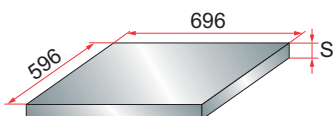

| PBA-P | |
|-------|----|
| S | 46 |
| | 56 |

mat.: 1.1730

PC-P

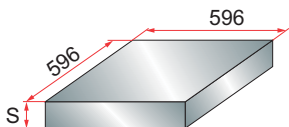

| S | Material | | | |
|-----|----------|--------|--------|--------|
| | 1.1730 | 1.2311 | 1.2312 | 1.2085 |
| 27 | * | * | * | o |
| 36 | * | * | * | o |
| 46 | * | * | * | o |
| 56 | * | * | * | o |
| 66 | * | * | * | o |
| 76 | * | * | * | o |
| 86 | * | * | * | o |
| 96 | * | * | * | o |
| 116 | * | * | * | o |
| 136 | * | * | * | o |
| 156 | * | * | * | o |

^o Entrega 3/4 días - Delivery 3/4 days

ESP-P

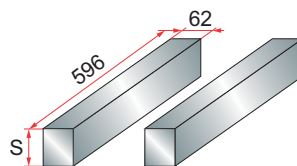

| ESP-P | |
|-------|-----|
| S | 76 |
| | 86 |
| | 96 |
| | 116 |
| | 136 |
| | 156 |

mat.: 1.1730

PS-P

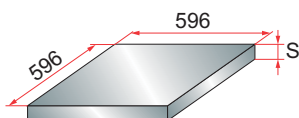

| PS-P | |
|------|----|
| S | 46 |
| | 56 |

mat.: 1.1730

CPE-P

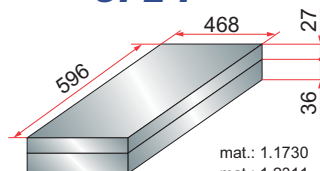

mat.: 1.1730
mat.: 1.2311