

446.446

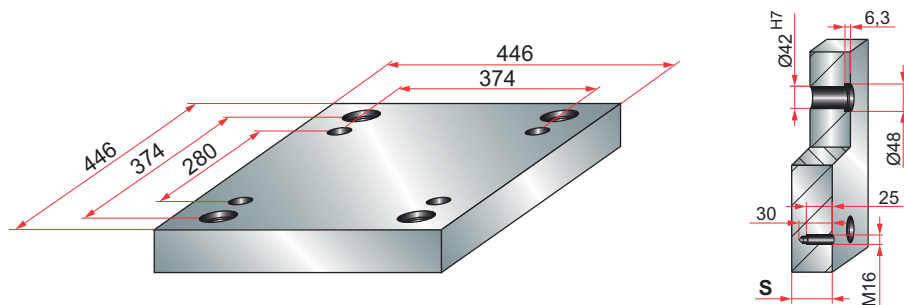

PBA

PBA	
S	36
	46

mat.: 1.1730

PBA-EU

PBA-EU	
S	36
	46

mat.: 1.1730

PBAV

PBAV	
S	36
	46

mat.: 1.1730

PBAV-EU

PBAV-EU	
S	36
	46

mat.: 1.1730

PBAS

PBAS	
S	36
	46

mat.: 1.1730

PBAS-EU

PBAS-EU	
S	36
	46

mat.: 1.1730

PC

		Material			
		1.1730	1.2311	1.2312	1.2085
S	27	*	*	*	o
	36	*	*	*	o
	46	*	*	*	o
	56	*	*	*	o
	66	*	*	*	o
	76	*	*	*	o
	86	*	*	*	o
	96	*	*	*	o
	116	*	*	*	o
	136	*	*	*	o
156	*	*	*	o	

° Entrega 3/4 días - Delivery 3/4 days

PCX

		Material		
		1.2311	1.2312	1.2085
S	27	*	*	o
	36	*	*	o
	46	*	*	o
	56	*	*	o
	66	*	*	o
	76	*	*	o
	86	*	*	o
	96	*	*	o
	116	*	*	o
	136	*	*	o
156	*	*	o	

° Entrega 3/4 días - Delivery 3/4 days

446.446

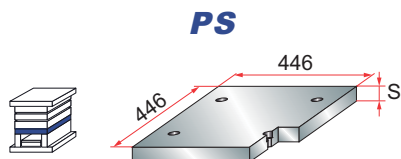

PS	
S	36 46

mat.: 1.1730

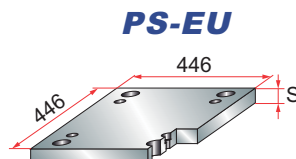

PS-EU	
S	36 46

mat.: 1.1730

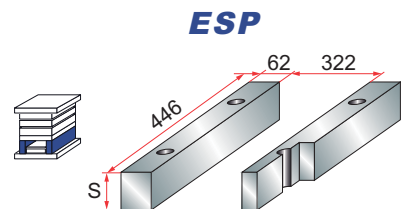

ESP	
S	56 66 76 86 96 116

mat.: 1.1730

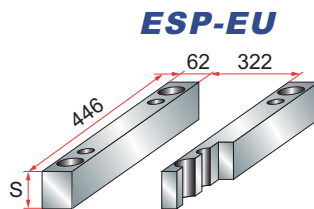

ESP-EU	
S	56 66 76 86 96 116

mat.: 1.1730

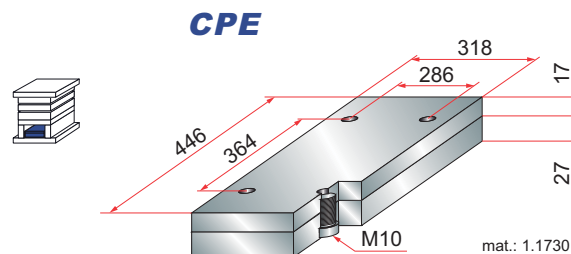

mat.: 1.1730

P PLATES

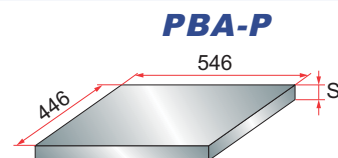

PBA-P	
S	36 46

mat.: 1.1730

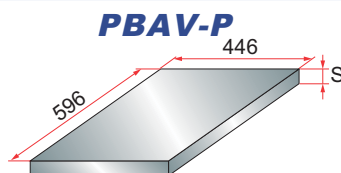

PBAV-P	
S	36 46

mat.: 1.1730

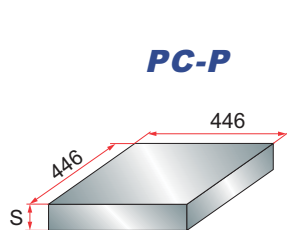

		Material			
		1.1730	1.2311	1.2312	1.2085
S	27	*	*	*	o
	36	*	*	*	o
	46	*	*	*	o
	56	*	*	*	o
	66	*	*	*	o
	76	*	*	*	o
	86	*	*	*	o
	96	*	*	*	o
	116	*	*	*	o
	136	*	*	*	o
156	*	*	*	o	

° Entrega 3/4 dias - Delivery 3/4 days

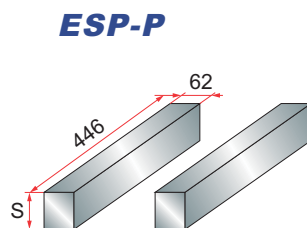

ESP-P	
S	56 66 76 86 96 116

mat.: 1.1730

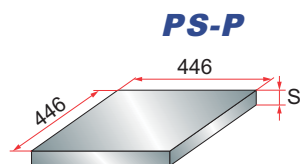

PS-P	
S	36 46

mat.: 1.1730

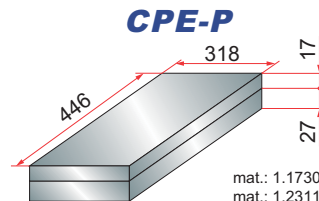

mat.: 1.1730
mat.: 1.2311