

Guide pillar without centering collar BR03
 Guía de doble diámetro BR03
 Słup prowadzący
 Guia principal sem centrador BR03
 Colonne de guidage epaulee monobloc type BR03

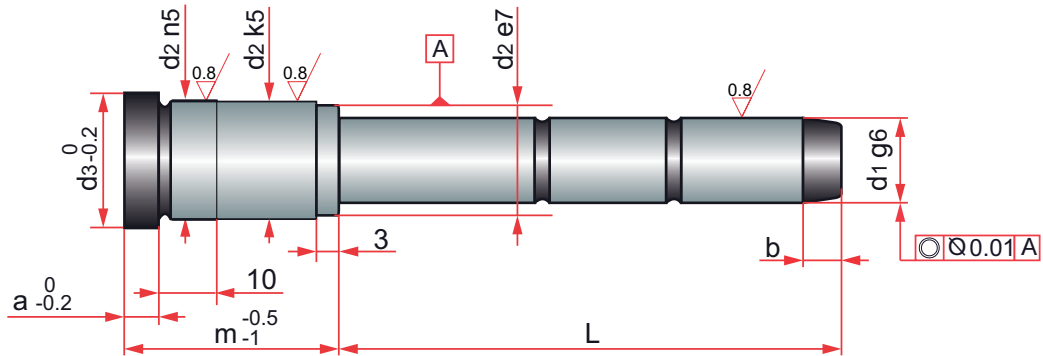

Hardness: 58 ± 2 HRC.

| a | b | d3 | d2 | d1 | m | L | REF. | d1 | REF. |
|----|-----------------|----|----|----|----|----|-----------------|----|-----------------|
| 3 | 4 | 16 | 14 | 10 | 12 | 25 | BR03/10x012x025 | - | - |
| | | | | | | 35 | BR03/10x012x035 | | |
| | | | | | | 55 | BR03/10x012x055 | | |
| | | | | | 17 | 25 | BR03/10x017x025 | | |
| | | | | | | 30 | BR03/10x017x030 | | |
| | | | | | | 35 | BR03/10x017x035 | | |
| | | | | | 22 | 25 | BR03/10x022x025 | | |
| | | | | | | 35 | BR03/10x022x035 | | |
| | | | | | | 55 | BR03/10x022x055 | | |
| | | | | | 27 | 35 | BR03/10x027x035 | | |
| | | | | | | 50 | BR03/10x027x050 | | |
| | | | | | | 55 | BR03/10x027x055 | | |
| | | | | | 36 | 35 | BR03/10x036x035 | | |
| | | | | | | 45 | BR03/10x036x045 | | |
| | | | | | | 55 | BR03/10x036x055 | | |
| | | | | | 46 | 35 | BR03/10x046x035 | | |
| | | | | | | 55 | BR03/10x046x055 | | |
| | | | | | | 75 | BR03/10x046x075 | | |
| | | | | | 56 | 35 | BR03/10x056x035 | | |
| | | | | | | 55 | BR03/10x056x055 | | |
| 75 | BR03/10x056x075 | | | | | | | | |
| 6 | 7 | 25 | 20 | 14 | 22 | 20 | BR03/14x022x020 | 15 | BR03/15x022x020 |

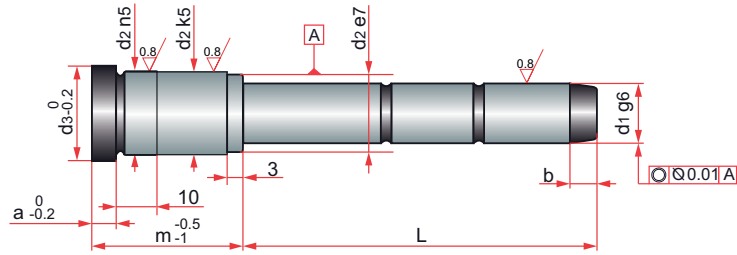

| a | b | d3 | d2 | d1 | m | L | REF. | d1 | REF. |
|---|---|----|----|-----|-----|-----------------|-----------------|----|-----------------|
| 6 | 7 | 25 | 20 | 14 | 22 | 35 | BR03/14x022x035 | 15 | BR03/15x022x035 |
| | | | | | | 45 | BR03/14x022x045 | | BR03/15x022x045 |
| | | | | | | 55 | BR03/14x022x055 | | BR03/15x022x055 |
| | | | | | | 65 | BR03/14x022x065 | | BR03/15x022x065 |
| | | | | | | 90 | BR03/14x022x090 | | BR03/15x022x090 |
| | | | | | 27 | 20 | BR03/14x027x020 | | BR03/15x027x020 |
| | | | | | | 35 | BR03/14x027x035 | | BR03/15x027x035 |
| | | | | | | 45 | BR03/14x027x045 | | BR03/15x027x045 |
| | | | | | | 55 | BR03/14x027x055 | | BR03/15x027x055 |
| | | | | | | 65 | BR03/14x027x065 | | BR03/15x027x065 |
| | | | | | | 85 | BR03/14x027x085 | | BR03/15x027x085 |
| | | | | | | 115 | BR03/14x027x115 | | BR03/15x027x115 |
| | | | | | | 135 | BR03/14x027x135 | | BR03/15x027x135 |
| | | | | | 36 | 20 | BR03/14x036x020 | | BR03/15x036x020 |
| | | | | | | 35 | BR03/14x036x035 | | BR03/15x036x035 |
| | | | | | | 45 | BR03/14x036x045 | | BR03/15x036x045 |
| | | | | | | 55 | BR03/14x036x055 | | BR03/15x036x055 |
| | | | | | | 65 | BR03/14x036x065 | | BR03/15x036x065 |
| | | | | | | 95 | BR03/14x036x095 | | BR03/15x036x095 |
| | | | | | | 115 | BR03/14x036x115 | | BR03/15x036x115 |
| | | | | 135 | | BR03/14x036x135 | BR03/15x036x135 | | |
| | | | | 46 | 20 | BR03/14x046x020 | BR03/15x046x020 | | |
| | | | | | 35 | BR03/14x046x035 | BR03/15x046x035 | | |
| | | | | | 45 | BR03/14x046x045 | BR03/15x046x045 | | |
| | | | | | 65 | BR03/14x046x065 | BR03/15x046x065 | | |
| | | | | | 85 | BR03/14x046x085 | BR03/15x046x085 | | |
| | | | | | 105 | BR03/14x046x105 | BR03/15x046x105 | | |
| | | | | | 135 | BR03/14x046x135 | BR03/15x046x135 | | |
| | | | | 56 | 20 | BR03/14x056x020 | BR03/15x056x020 | | |
| | | | | | 35 | BR03/14x056x035 | BR03/15x056x035 | | |
| | | | | | 55 | BR03/14x056x055 | BR03/15x056x055 | | |
| | | | | | 75 | BR03/14x056x075 | BR03/15x056x075 | | |

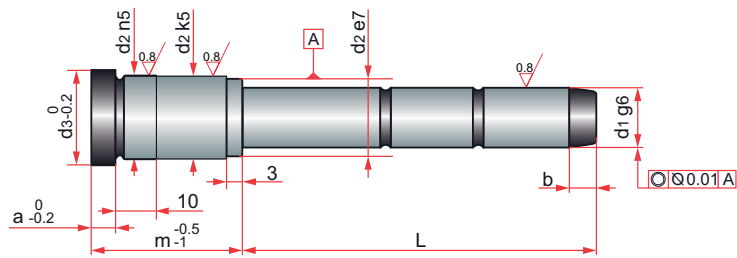

| a | b | d3 | d2 | d1 | m | L | REF. | d1 | REF. |
|---|---|-----|-----------------|-----------------|-----------------|-----------------|-----------------|-----------------|-----------------|
| 6 | 7 | 25 | 20 | 14 | 56 | 95 | BR03/14x056x095 | 15 | BR03/15x056x095 |
| | | | | | | 115 | BR03/14x056x115 | | BR03/15x056x115 |
| | | | | | | 135 | BR03/14x056x135 | | BR03/15x056x135 |
| | | | | | 66 | 25 | BR03/14x066x025 | | BR03/15x066x025 |
| | | | | | | 35 | BR03/14x066x035 | | BR03/15x066x035 |
| | | | | | | 55 | BR03/14x066x055 | | BR03/15x066x055 |
| | | | | | | 65 | BR03/14x066x065 | | BR03/15x066x065 |
| | | | | | | 95 | BR03/14x066x095 | | BR03/15x066x095 |
| | | | | | | 135 | BR03/14x066x135 | | BR03/15x066x135 |
| | | | | 76 | 35 | BR03/14x076x035 | BR03/15x076x035 | | |
| | | | | | 55 | BR03/14x076x055 | BR03/15x076x055 | | |
| | | | | | 75 | BR03/14x076x075 | BR03/15x076x075 | | |
| | | | | | 95 | BR03/14x076x095 | BR03/15x076x095 | | |
| | | | | | 115 | BR03/14x076x115 | BR03/15x076x115 | | |
| | | | | | 135 | BR03/14x076x135 | BR03/15x076x135 | | |
| | | | | 86 | 55 | BR03/14x086x055 | BR03/15x086x055 | | |
| | | | | | 75 | BR03/14x086x075 | BR03/15x086x075 | | |
| | | | | | 95 | BR03/14x086x095 | BR03/15x086x095 | | |
| | | 115 | BR03/14x086x115 | | BR03/15x086x115 | | | | |
| | | 96 | 35 | BR03/14x096x035 | BR03/15x096x035 | | | | |
| | | | 55 | BR03/14x096x055 | BR03/15x096x055 | | | | |
| | | | 75 | BR03/14x096x075 | BR03/15x096x075 | | | | |
| | | | 115 | BR03/14x096x115 | BR03/15x096x115 | | | | |
| | | | 135 | BR03/14x096x135 | BR03/15x096x135 | | | | |
| | | | 31 | 26 | 18 | 22 | 20 | BR03/18x022x020 | 20 |
| | | 35 | | | | | BR03/18x022x035 | BR03/20x022x035 | |
| | | 45 | | | | | BR03/18x022x045 | BR03/20x022x045 | |
| | | 55 | | | | | BR03/18x022x055 | BR03/20x022x055 | |
| | | 65 | | | | | BR03/18x022x065 | BR03/20x022x065 | |
| | | 85 | | | | | BR03/18x022x085 | BR03/20x022x085 | |
| | | 27 | | | 20 | 20 | BR03/18x027x020 | BR03/20x027x020 | |
| | | | | | | 35 | BR03/18x027x035 | BR03/20x027x035 | |

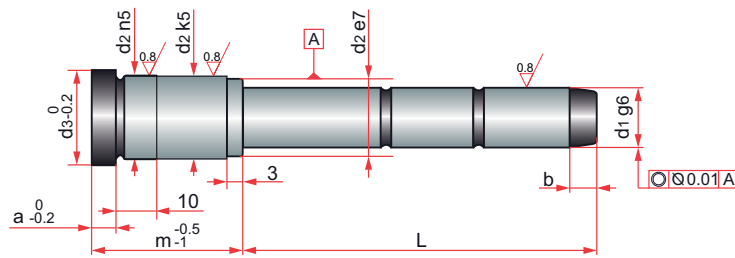

| a | b | d3 | d2 | d1 | m | L | REF. | d1 | REF. |
|---|---|----|----|----|-----|-----|-----------------|----|-----------------|
| 6 | 7 | 31 | 26 | 18 | 27 | 45 | BR03/18x027x045 | 20 | BR03/20x027x045 |
| | | | | | | 55 | BR03/18x027x055 | | BR03/20x027x055 |
| | | | | | | 65 | BR03/18x027x065 | | BR03/20x027x065 |
| | | | | | | 85 | BR03/18x027x085 | | BR03/20x027x085 |
| | | | | | | 105 | BR03/18x027x105 | | BR03/20x027x105 |
| | | | | | | 135 | BR03/18x027x135 | | BR03/20x027x135 |
| | | | | | 36 | 20 | BR03/18x036x020 | | BR03/20x036x020 |
| | | | | | | 35 | BR03/18x036x035 | | BR03/20x036x035 |
| | | | | | | 45 | BR03/18x036x045 | | BR03/20x036x045 |
| | | | | | | 55 | BR03/18x036x055 | | BR03/20x036x055 |
| | | | | | | 65 | BR03/18x036x065 | | BR03/20x036x065 |
| | | | | | | 75 | BR03/18x036x075 | | BR03/20x036x075 |
| | | | | | | 95 | BR03/18x036x095 | | BR03/20x036x095 |
| | | | | | | 115 | BR03/18x036x115 | | BR03/20x036x115 |
| | | | | | | 135 | BR03/18x036x135 | | BR03/20x036x135 |
| | | | | | | 46 | 20 | | BR03/18x046x020 |
| | | | | | 45 | | BR03/18x046x045 | | BR03/20x046x045 |
| | | | | | 65 | | BR03/18x046x065 | | BR03/20x046x065 |
| | | | | | 85 | | BR03/18x046x085 | | BR03/20x046x085 |
| | | | | | 105 | | BR03/18x046x105 | | BR03/20x046x105 |
| | | | | | 135 | | BR03/18x046x135 | | BR03/20x046x135 |
| | | | | | 56 | 20 | BR03/18x056x020 | | BR03/20x056x020 |
| | | | | | | 35 | BR03/18x056x035 | | BR03/20x056x035 |
| | | | | | | 55 | BR03/18x056x055 | | BR03/20x056x055 |
| | | | | | | 75 | BR03/18x056x075 | | BR03/20x056x075 |
| | | | | | | 95 | BR03/18x056x095 | | BR03/20x056x095 |
| | | | | | | 115 | BR03/18x056x115 | | BR03/20x056x115 |
| | | | | | 66 | 35 | BR03/18x066x035 | | BR03/20x066x035 |
| | | | | | | 55 | BR03/18x066x055 | | BR03/20x066x055 |
| | | | | | | 75 | BR03/18x066x075 | | BR03/20x066x075 |
| | | | | | | 95 | BR03/18x066x095 | | BR03/20x066x095 |

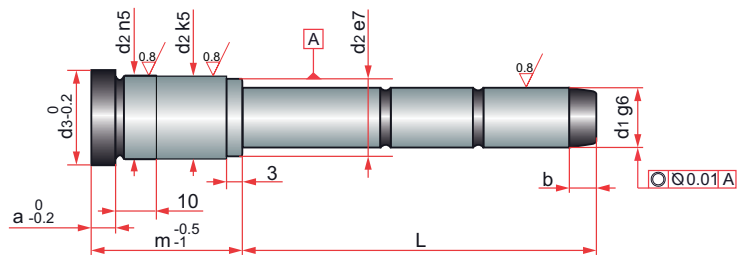

| a | b | d3 | d2 | d1 | m | L | REF. | d1 | REF. | |
|---|---|----|----|----|-----|-----|-----------------|----|-----------------|-----------------|
| 6 | 7 | 35 | 30 | 22 | 36 | 115 | BR03/22x036x115 | 24 | BR03/24x036x115 | |
| | | | | | | 155 | BR03/22x036x155 | | BR03/24x036x155 | |
| | | | | | | 205 | BR03/22x036x205 | | BR03/24x036x205 | |
| | | | | | 46 | 25 | BR03/22x046x025 | | BR03/24x046x025 | |
| | | | | | | 35 | BR03/22x046x035 | | BR03/24x046x035 | |
| | | | | | | 45 | BR03/22x046x045 | | BR03/24x046x045 | |
| | | | | | | 65 | BR03/22x046x065 | | BR03/24x046x065 | |
| | | | | | | 75 | BR03/22x046x075 | | BR03/24x046x075 | |
| | | | | | | 85 | BR03/22x046x085 | | BR03/24x046x085 | |
| | | | | | | 105 | BR03/22x046x105 | | BR03/24x046x105 | |
| | | | | | | 125 | BR03/22x046x125 | | BR03/24x046x125 | |
| | | | | | | 155 | BR03/22x046x155 | | BR03/24x046x155 | |
| | | | | | | 205 | BR03/22x046x205 | | BR03/24x046x205 | |
| | | | | | | 56 | 25 | | BR03/22x056x025 | BR03/24x056x025 |
| | | | | | | | 45 | | BR03/22x056x045 | BR03/24x056x045 |
| | | | | | 55 | | BR03/22x056x055 | | BR03/24x056x055 | |
| | | | | | 75 | | BR03/22x056x075 | | BR03/24x056x075 | |
| | | | | | 95 | | BR03/22x056x095 | | BR03/24x056x095 | |
| | | | | | 115 | | BR03/22x056x115 | | BR03/24x056x115 | |
| | | | | | 155 | | BR03/22x056x155 | | BR03/24x056x155 | |
| | | | | | 205 | | BR03/22x056x205 | | BR03/24x056x205 | |
| | | | | | 66 | 35 | BR03/22x066x035 | | BR03/24x066x035 | |
| | | | | | | 55 | BR03/22x066x055 | | BR03/24x066x055 | |
| | | | | | | 75 | BR03/22x066x075 | | BR03/24x066x075 | |
| | | | | | | 95 | BR03/22x066x095 | | BR03/24x066x095 | |
| | | | | | | 155 | BR03/22x066x155 | | BR03/24x066x155 | |
| | | | | | | 205 | BR03/22x066x205 | | BR03/24x066x205 | |
| | | | | | 76 | 25 | BR03/22x076x025 | | BR03/24x076x025 | |
| | | | | | | 45 | BR03/22x076x045 | | BR03/24x076x045 | |
| | | | | | | 55 | BR03/22x076x055 | | BR03/24x076x055 | |
| | | | | | | 75 | BR03/22x076x075 | | BR03/24x076x075 | |
| | | | | | | 95 | BR03/22x076x095 | | BR03/24x076x095 | |

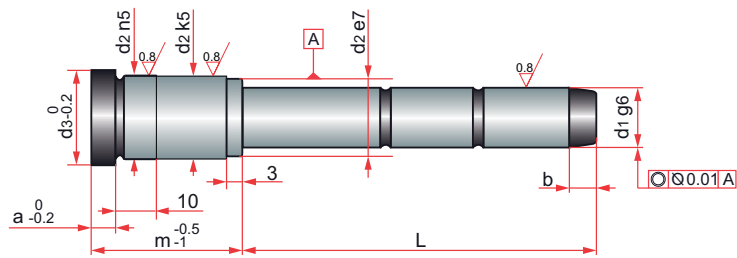

| a | b | d3 | d2 | d1 | m | L | REF. | d1 | REF. | |
|----|-----------------|-----|-----------------|-----------------|-----------------|-----|-----------------|-----------------|-----------------|-----------------|
| 6 | 7 | 35 | 30 | 22 | 76 | 115 | BR03/22x076x115 | 24 | BR03/24x076x115 | |
| | | | | | | 155 | BR03/22x076x155 | | BR03/24x076x155 | |
| | | | | | | 205 | BR03/22x076x205 | | BR03/24x076x205 | |
| | | | | | 86 | 55 | BR03/22x086x055 | | BR03/24x086x055 | |
| | | | | | | 75 | BR03/22x086x075 | | BR03/24x086x075 | |
| | | | | | | 95 | BR03/22x086x095 | | BR03/24x086x095 | |
| | | | | | | 115 | BR03/22x086x115 | | BR03/24x086x115 | |
| | | | | | | 155 | BR03/22x086x155 | | BR03/24x086x155 | |
| | | | | | 96 | 205 | BR03/22x086x205 | | BR03/24x086x205 | |
| | | | | | | 55 | BR03/22x096x055 | | BR03/24x096x055 | |
| | | | | | | 75 | BR03/22x096x075 | | BR03/24x096x075 | |
| | | | | | | 95 | BR03/22x096x095 | | BR03/24x096x095 | |
| | | | | | | 155 | BR03/22x096x155 | | BR03/24x096x155 | |
| | | | | | 116 | 205 | BR03/22x096x205 | | BR03/24x096x205 | |
| | | | | | | 75 | BR03/22x116x075 | | BR03/24x116x075 | |
| | | | | | | 95 | BR03/22x116x095 | | BR03/24x116x095 | |
| | | 115 | BR03/22x116x115 | BR03/24x116x115 | | | | | | |
| | | 155 | BR03/22x116x155 | BR03/24x116x155 | | | | | | |
| | | 136 | 205 | BR03/22x116x205 | BR03/24x116x205 | | | | | |
| | | | 75 | BR03/22x136x075 | BR03/24x136x075 | | | | | |
| | | | 95 | BR03/22x136x095 | BR03/24x136x095 | | | | | |
| | | | 135 | BR03/22x136x135 | BR03/24x136x135 | | | | | |
| | | | 155 | BR03/22x136x155 | BR03/24x136x155 | | | | | |
| | | 47 | 42 | 30 | 27 | 36 | 35 | BR03/30x027x035 | 32 | BR03/32x027x035 |
| | | | | | | | 45 | BR03/30x027x045 | | BR03/32x027x045 |
| | | | | | | | 65 | BR03/30x027x065 | | BR03/32x027x065 |
| | | | | | | | 105 | BR03/30x027x105 | | BR03/32x027x105 |
| | | | | | | 36 | 35 | BR03/30x036x035 | | BR03/32x036x035 |
| 55 | BR03/30x036x055 | | | | | | BR03/32x036x055 | | | |
| 75 | BR03/30x036x075 | | | | | | BR03/32x036x075 | | | |
| 95 | BR03/30x036x095 | | | | | | BR03/32x036x095 | | | |

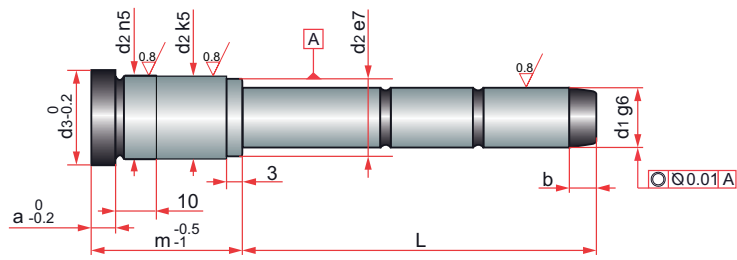

| a | b | d3 | d2 | d1 | m | L | REF. | d1 | REF. |
|---|---|----|----|----|-----|-----|-----------------|----|-----------------|
| 6 | 7 | 47 | 42 | 30 | 36 | 115 | BR03/30x036x115 | 32 | BR03/32x036x115 |
| | | | | | | 135 | BR03/30x036x135 | | BR03/32x036x135 |
| | | | | | | 205 | BR03/30x036x205 | | BR03/32x036x205 |
| | | | | | 46 | 45 | BR03/30x046x045 | | BR03/32x046x045 |
| | | | | | | 75 | BR03/30x046x075 | | BR03/32x046x075 |
| | | | | | | 85 | BR03/30x046x085 | | BR03/32x046x085 |
| | | | | | | 105 | BR03/30x046x105 | | BR03/32x046x105 |
| | | | | | | 125 | BR03/30x046x125 | | BR03/32x046x125 |
| | | | | | | 135 | BR03/30x046x135 | | BR03/32x046x135 |
| | | | | | | 205 | BR03/30x046x205 | | BR03/32x046x205 |
| | | | | | | 56 | 35 | | BR03/30x056x035 |
| | | | | | 55 | | BR03/30x056x055 | | BR03/32x056x055 |
| | | | | | 75 | | BR03/30x056x075 | | BR03/32x056x075 |
| | | | | | 95 | | BR03/30x056x095 | | BR03/32x056x095 |
| | | | | | 115 | | BR03/30x056x115 | | BR03/32x056x115 |
| | | | | | 135 | | BR03/30x056x135 | | BR03/32x056x135 |
| | | | | | 205 | | BR03/30x056x205 | | BR03/32x056x205 |
| | | | | | 66 | 35 | BR03/30x066x035 | | BR03/32x066x035 |
| | | | | | | 55 | BR03/30x066x055 | | BR03/32x066x055 |
| | | | | | | 75 | BR03/30x066x075 | | BR03/32x066x075 |
| | | | | | | 95 | BR03/30x066x095 | | BR03/32x066x095 |
| | | | | | | 115 | BR03/30x066x115 | | BR03/32x066x115 |
| | | | | | | 135 | BR03/30x066x135 | | BR03/32x066x135 |
| | | | | | | 205 | BR03/30x066x205 | | BR03/32x066x205 |
| | | | | | 76 | 35 | BR03/30x076x035 | | BR03/32x076x035 |
| | | | | | | 55 | BR03/30x076x055 | | BR03/32x076x055 |
| | | | | | | 75 | BR03/30x076x075 | | BR03/32x076x075 |
| | | | | | | 95 | BR03/30x076x095 | | BR03/32x076x095 |
| | | | | | | 115 | BR03/30x076x115 | | BR03/32x076x115 |
| | | | | | | 155 | BR03/30x076x155 | | BR03/32x076x155 |
| | | | | | | 205 | BR03/30x076x205 | | BR03/32x076x205 |
| | | | | | 86 | 55 | BR03/30x086x055 | | BR03/32x086x055 |

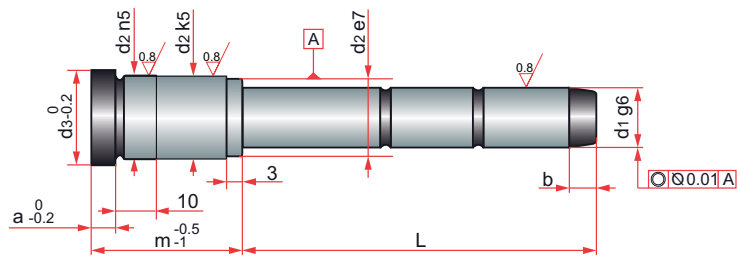

| a | b | d3 | d2 | d1 | m | L | REF. | d1 | REF. | | | | | | |
|-----|-----------------|-----------------|-----------------|-----------------|-----|-----|-----------------|----|-----------------|----|----|----|-----------------|----|-----------------|
| 6 | 7 | 47 | 42 | 30 | 86 | 75 | BR03/30x086x075 | 32 | BR03/32x086x075 | | | | | | |
| | | | | | | 95 | BR03/30x086x095 | | BR03/32x086x095 | | | | | | |
| | | | | | | 115 | BR03/30x086x115 | | BR03/32x086x115 | | | | | | |
| | | | | | | 155 | BR03/30x086x155 | | BR03/32x086x155 | | | | | | |
| | | | | | | 205 | BR03/30x086x205 | | BR03/32x086x205 | | | | | | |
| | | | | | 96 | 55 | BR03/30x096x055 | | BR03/32x096x055 | | | | | | |
| | | | | | | 75 | BR03/30x096x075 | | BR03/32x096x075 | | | | | | |
| | | | | | | 95 | BR03/30x096x095 | | BR03/32x096x095 | | | | | | |
| | | | | | | 115 | BR03/30x096x115 | | BR03/32x096x115 | | | | | | |
| | | | | | | 155 | BR03/30x096x155 | | BR03/32x096x155 | | | | | | |
| | | | | | 116 | 45 | BR03/30x116x045 | | BR03/32x116x045 | | | | | | |
| | | | | | | 75 | BR03/30x116x075 | | BR03/32x116x075 | | | | | | |
| | | | | | | 115 | BR03/30x116x115 | | BR03/32x116x115 | | | | | | |
| | | | | | | 155 | BR03/30x116x155 | | BR03/32x116x155 | | | | | | |
| | | | | | | 205 | BR03/30x116x205 | | BR03/32x116x205 | | | | | | |
| | | | | | 136 | 95 | BR03/30x136x095 | | BR03/32x136x095 | | | | | | |
| | | | | | | 115 | BR03/30x136x115 | | BR03/32x136x115 | | | | | | |
| | | | | | | 155 | BR03/30x136x155 | | BR03/32x136x155 | | | | | | |
| | | | | | | 205 | BR03/30x136x205 | | BR03/32x136x205 | | | | | | |
| | | | | | 156 | 115 | BR03/30x156x115 | | BR03/32x156x115 | | | | | | |
| | | | | | | 155 | BR03/30x156x155 | | BR03/32x156x155 | | | | | | |
| | | | | | | 205 | BR03/30x156x205 | | BR03/32x156x205 | | | | | | |
| | | | | | 10 | 10 | 59 | | 54 | 40 | 36 | 75 | BR03/40x036x075 | 42 | BR03/42x036x075 |
| | | | | | | | | | | | | 95 | BR03/40x036x095 | | BR03/42x036x095 |
| 115 | BR03/40x036x115 | BR03/42x036x115 | | | | | | | | | | | | | |
| 155 | BR03/40x036x155 | BR03/42x036x155 | | | | | | | | | | | | | |
| 46 | 75 | BR03/40x046x075 | BR03/42x046x075 | | | | | | | | | | | | |
| | 95 | BR03/40x046x095 | BR03/42x046x095 | | | | | | | | | | | | |
| | 115 | BR03/40x046x115 | BR03/42x046x115 | | | | | | | | | | | | |
| | 155 | BR03/40x046x155 | BR03/42x046x155 | | | | | | | | | | | | |
| | 56 | 75 | BR03/40x056x075 | BR03/42x056x075 | | | | | | | | | | | |

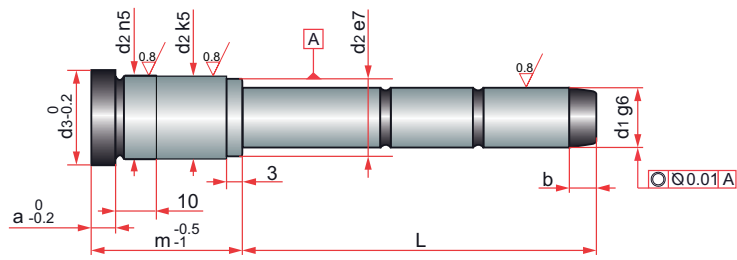

| a | b | d3 | d2 | d1 | m | L | REF. | d1 | REF. |
|----|----|----|----|----|-----|-----|-----------------|-----------------|-----------------|
| 10 | 10 | 59 | 54 | 40 | 56 | 95 | BR03/40x056x095 | 42 | BR03/42x056x095 |
| | | | | | | 115 | BR03/40x056x115 | | BR03/42x056x115 |
| | | | | | | 155 | BR03/40x056x155 | | BR03/42x056x155 |
| | | | | | 66 | 75 | BR03/40x066x075 | BR03/42x066x075 | |
| | | | | | | 95 | BR03/40x066x095 | BR03/42x066x095 | |
| | | | | | | 115 | BR03/40x066x115 | BR03/42x066x115 | |
| | | | | | | 155 | BR03/40x 66x155 | BR03/42x066x155 | |
| | | | | | 76 | 75 | BR03/40x076x075 | BR03/42x076x075 | |
| | | | | | | 95 | BR03/40x076x095 | BR03/42x076x095 | |
| | | | | | | 115 | BR03/40x076x115 | BR03/42x076x115 | |
| | | | | | | 155 | BR03/40x076x155 | BR03/42x076x155 | |
| | | | | | 86 | 75 | BR03/40x086x075 | BR03/42x086x075 | |
| | | | | | | 95 | BR03/40x086x095 | BR03/42x086x095 | |
| | | | | | | 115 | BR03/40x086x115 | BR03/42x086x115 | |
| | | | | | | 155 | BR03/40x086x155 | BR03/42x086x155 | |
| | | | | | 96 | 75 | BR03/40x096x075 | BR03/42x096x075 | |
| | | | | | | 95 | BR03/40x096x095 | BR03/42x096x095 | |
| | | | | | | 115 | BR03/40x096x115 | BR03/42x096x115 | |
| | | | | | | 155 | BR03/40x096x155 | BR03/42x096x155 | |
| | | | | | 116 | 75 | BR03/40x116x075 | BR03/42x116x075 | |
| | | | | | | 95 | BR03/40x116x095 | BR03/42x116x095 | |
| | | | | | | 115 | BR03/40x116x115 | BR03/42x116x115 | |
| | | | | | | 155 | BR03/40x116x155 | BR03/42x116x155 | |
| | | | | | 136 | 95 | BR03/40x136x095 | BR03/42x136x095 | |
| | | | | | | 115 | BR03/40x136x115 | BR03/42x136x115 | |
| | | | | | | 135 | BR03/40x136x135 | BR03/42x136x135 | |
| | | | | | | 155 | BR03/40x136x155 | BR03/42x136x155 | |
| | | | | | | 195 | BR03/40x136x195 | BR03/42x136x195 | |
| | | | | | 156 | 115 | BR03/40x156x115 | BR03/42x156x115 | |
| | | | | | | 135 | BR03/40x156x135 | BR03/42x156x135 | |
| | | | | | | 155 | BR03/40x156x155 | BR03/42x156x155 | |
| | | | | | | 195 | BR03/40x156x195 | BR03/42x156x195 | |

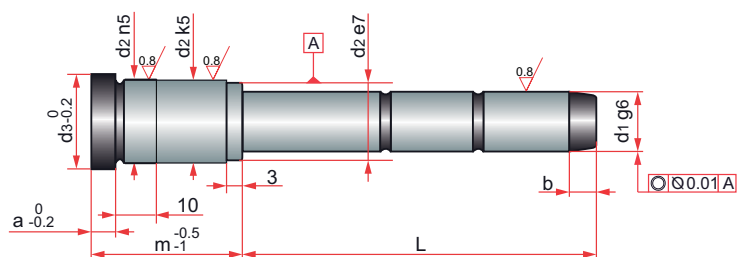

| a | b | d3 | d2 | d1 | m | L | REF. | d1 | REF. |
|----|----|----|----|----|-----|-----|-----------------|----|-----------------|
| 10 | 10 | 59 | 54 | 40 | 176 | 115 | BR03/40x176x115 | 42 | BR03/42x176x115 |
| | | | | | | 155 | BR03/40x176x155 | | BR03/42x176x155 |
| | | | | | | 195 | BR03/40x176x195 | | BR03/42x176x195 |
| | | | | | 196 | 115 | BR03/40x196x115 | | BR03/42x196x115 |
| | | | | | | 155 | BR03/40x196x155 | | BR03/42x196x155 |
| | | | | | | 195 | BR03/40x196x195 | | BR03/42x196x195 |
| | | | | | 216 | 195 | BR03/40x216x195 | | BR03/42x216x195 |
| | | | | | | 215 | BR03/40x216x215 | | BR03/42x216x215 |
| | | | | | 236 | 205 | BR03/40x236x205 | | BR03/42x236x205 |
| | | | | | | 235 | BR03/40x236x235 | | BR03/42x236x235 |
| | | | | | 246 | 215 | BR03/40x246x215 | | BR03/42x246x215 |
| | | | | | | 245 | BR03/40x246x245 | | BR03/42x246x245 |
| | | | | | 256 | 215 | BR03/40x256x215 | | BR03/42x256x215 |
| | | | | | | 255 | BR03/40x256x255 | | BR03/42x256x255 |