

Ejector pin nitrided polished
 Expulsor nitrurado pulido
 Wypychacz azotowany polerowany
 Extrator nitrurado pulido
 Ejecteur nitrure rode

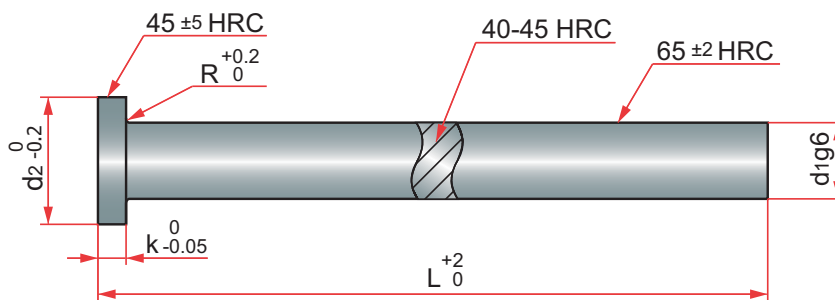

Mat. : 1.2344 DIN 1530A / ISO 6751 - Maximum temperature at work: 550° C.

| R | k | d2 | d1 | L | REF. | | |
|-----|-----|---------------|---------------|---------------|---------------|---------------|---------------|
| 0,2 | 1,2 | 2,5 | 0,8 | 100 | AP/00'80x0100 | | |
| | | | | 125 | AP/00'80x0125 | | |
| | | | | 160 | AP/00'80x0160 | | |
| | | | | 100 | AP/00'90x0100 | | |
| | | | | 125 | AP/00'90x0125 | | |
| | | 1,0 | 100 | AP/01'00x0100 | | | |
| | | | 125 | AP/01'00x0125 | | | |
| | | | 160 | AP/01'00x0160 | | | |
| | | | 200 | AP/01'00x0200 | | | |
| | | | 250 | AP/01'00x0250 | | | |
| | 1,2 | 100 | AP/01'20x0100 | | | | |
| | | 125 | AP/01'20x0125 | | | | |
| | | 160 | AP/01'20x0160 | | | | |
| | | 200 | AP/01'20x0200 | | | | |
| | | 1,5 | 3 | 1,5 | 100 | AP/01'50x0100 | |
| | 125 | | | | AP/01'50x0125 | | |
| | 160 | | | | AP/01'50x0160 | | |
| | 200 | | | | AP/01'50x0200 | | |
| | 1,7 | | | | 100 | AP/01'70x0100 | |
| | | | 125 | AP/01'70x0125 | | | |
| 160 | | | AP/01'70x0160 | | | | |
| 200 | | | AP/01'70x0200 | | | | |
| 2 | | | 4 | 2,0 | 100 | AP/02'00x0100 | |
| | 125 | | | | AP/02'00x0125 | | |
| | 160 | AP/02'00x0160 | | | | | |
| | 0,3 | 5 | | | 2,4 | 125 | AP/02'40x0125 |
| | | | | | | 200 | AP/02'40x0200 |
| | | | | | | 315 | AP/02'40x0315 |
| 2,5 | | | 100 | AP/02'50x0100 | | | |
| | 125 | | AP/02'50x0125 | | | | |
| | 160 | | AP/02'50x0160 | | | | |
| | 200 | | AP/02'50x0200 | | | | |
| | 250 | | AP/02'50x0250 | | | | |
| | 315 | | AP/02'50x0315 | | | | |
| | 400 | | AP/02'50x0400 | | | | |

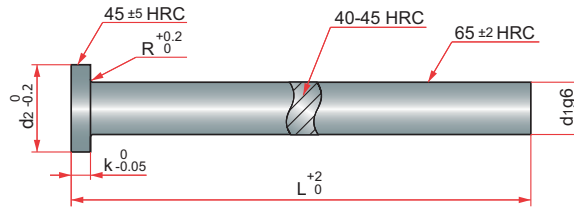

| R | k | d2 | d1 | L | REF. |
|-----|---------------|---------------|---------------|---------------|---------------|
| 0,3 | 2 | 5 | 2,6 | 125 | AP/02'60x0125 |
| | | | | 200 | AP/02'60x0200 |
| | | | | 315 | AP/02'60x0315 |
| | | | 2,7 | 100 | AP/02'70x0100 |
| | | | | 125 | AP/02'70x0125 |
| | | | | 160 | AP/02'70x0160 |
| | | | | 200 | AP/02'70x0200 |
| | | | | 250 | AP/02'70x0250 |
| | | | | 315 | AP/02'70x0315 |
| | | | 2,8 | 125 | AP/02'80x0125 |
| | | | | 200 | AP/02'80x0200 |
| | | | | 315 | AP/02'80x0315 |
| | 3 | 6 | 2,9 | 125 | AP/02'90x0125 |
| | | | | 200 | AP/02'90x0200 |
| | | | | 315 | AP/02'90x0315 |
| | | | 3,0 | 100 | AP/03'00x0100 |
| | | | | 125 | AP/03'00x0125 |
| | | | | 160 | AP/03'00x0160 |
| | | 200 | | AP/03'00x0200 | |
| | | 250 | | AP/03'00x0250 | |
| | | 315 | | AP/03'00x0315 | |
| | | 3,1 | 400 | AP/03'00x0400 | |
| | | | 500 | AP/03'00x0500 | |
| | | | 125 | AP/03'10x0125 | |
| 200 | AP/03'10x0200 | | | | |
| 315 | AP/03'10x0315 | | | | |
| 3,2 | 100 | | AP/03'20x0100 | | |
| | 125 | AP/03'20x0125 | | | |
| | 160 | AP/03'20x0160 | | | |
| | 200 | AP/03'20x0200 | | | |
| | 250 | AP/03'20x0250 | | | |
| | 315 | AP/03'20x0315 | | | |

| R | k | d2 | d1 | L | REF. | |
|-----|-----|---------------|---------------|---------------|---------------|---------------|
| 0,3 | 3 | 6 | 3,2 | 400 | AP/03'20x0400 | |
| | | | | 500 | AP/03'20x0500 | |
| | | | | 800 | AP/03'20x0800 | |
| | | | 3,3 | 125 | AP/03'30x0125 | |
| | | | | 200 | AP/03'30x0200 | |
| | | | | 3,4 | 125 | AP/03'40x0125 |
| | | | 200 | | AP/03'40x0200 | |
| | | | 315 | | AP/03'40x0315 | |
| | | | 7 | 3,5 | 100 | AP/03'50x0100 |
| | | | | | 125 | AP/03'50x0125 |
| | | | | | 160 | AP/03'50x0160 |
| | | | | 3,6 | 200 | AP/03'50x0200 |
| | | | | | 250 | AP/03'50x0250 |
| | | | | | 315 | AP/03'50x0315 |
| | | | | | 400 | AP/03'50x0400 |
| | | | | | 500 | AP/03'50x0500 |
| | | | | | 630 | AP/03'50x0630 |
| | | | 3,7 | 125 | AP/03'60x0125 | |
| | 200 | AP/03'60x0200 | | | | |
| | 3,8 | 100 | | AP/03'70x0100 | | |
| | | 125 | | AP/03'70x0125 | | |
| | | 160 | | AP/03'70x0160 | | |
| | 3,9 | 200 | | AP/03'70x0200 | | |
| | | 250 | AP/03'70x0250 | | | |
| | | 315 | AP/03'70x0315 | | | |
| | | 400 | AP/03'70x0400 | | | |
| | | 3,8 | 125 | AP/03'80x0125 | | |
| | | | 200 | AP/03'80x0200 | | |
| | 315 | | AP/03'80x0315 | | | |
| | 3,9 | 125 | AP/03'90x0125 | | | |
| | | 200 | AP/03'90x0200 | | | |
| | | 315 | AP/03'90x0315 | | | |

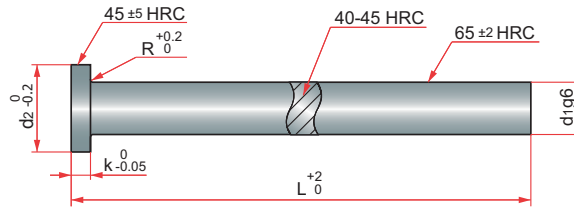

| R | k | d2 | d1 | L | REF. |
|-----|---|----|------|---------------|---------------|
| 0,3 | 3 | 8 | 4,0 | 100 | AP/04'00x0100 |
| | | | | 125 | AP/04'00x0125 |
| | | | | 160 | AP/04'00x0160 |
| | | | | 200 | AP/04'00x0200 |
| | | | | 250 | AP/04'00x0250 |
| | | | | 315 | AP/04'00x0315 |
| | | | | 400 | AP/04'00x0400 |
| | | | | 500 | AP/04'00x0500 |
| | | | | 630 | AP/04'00x0630 |
| | | | | 800 | AP/04'00x0800 |
| | | | 1000 | AP/04'00x1000 | |
| | | | 4,1 | 125 | AP/04'10x0125 |
| | | | | 200 | AP/04'10x0200 |
| | | | | 315 | AP/04'10x0315 |
| | | | 4,2 | 100 | AP/04'20x0100 |
| | | | | 125 | AP/04'20x0125 |
| | | | | 160 | AP/04'20x0160 |
| | | | | 200 | AP/04'20x0200 |
| | | | | 250 | AP/04'20x0250 |
| | | | | 315 | AP/04'20x0315 |
| | | | 4,3 | 125 | AP/04'30x0125 |
| | | | | 200 | AP/04'30x0200 |
| | | | 4,4 | 125 | AP/04'40x0125 |
| | | | | 200 | AP/04'40x0200 |
| | | | 4,5 | 100 | AP/04'50x0100 |
| | | | | 125 | AP/04'50x0125 |
| | | | | 160 | AP/04'50x0160 |
| | | | | 200 | AP/04'50x0200 |
| | | | | 250 | AP/04'50x0250 |
| | | | | 315 | AP/04'50x0315 |
| | | | 400 | AP/04'50x0400 | |

| R | k | d2 | d1 | L | REF. | | |
|-----|---------------|----|-----|------|---------------|---------------|---------------|
| 0,3 | 3 | 8 | 4,5 | 500 | AP/04'50x0500 | | |
| | | | | 630 | AP/04'50x0630 | | |
| | | | | 800 | AP/04'50x0800 | | |
| | | | | 1000 | AP/04'50x1000 | | |
| | | | 4,6 | 125 | AP/04'60x0125 | | |
| | | | | 200 | AP/04'60x0200 | | |
| | | | 4,7 | 125 | AP/04'70x0125 | | |
| | | | | 200 | AP/04'70x0200 | | |
| | | | | 315 | AP/04'70x0315 | | |
| | | | 4,8 | 125 | AP/04'80x0125 | | |
| | | | | 200 | AP/04'80x0200 | | |
| | | | 4,9 | 125 | AP/04'90x0125 | | |
| | | | | 200 | AP/04'90x0200 | | |
| | | | 10 | 5,0 | 100 | AP/05'00x0100 | |
| | | | | | 125 | AP/05'00x0125 | |
| | | | | | 160 | AP/05'00x0160 | |
| | | | | | 200 | AP/05'00x0200 | |
| | | | | | 250 | AP/05'00x0250 | |
| | | | | | 315 | AP/05'00x0315 | |
| | | | | | 400 | AP/05'00x0400 | |
| | | | | | 500 | AP/05'00x0500 | |
| | | | | | 630 | AP/05'00x0630 | |
| | | | | | 800 | AP/05'00x0800 | |
| | | | | | 1000 | AP/05'00x1000 | |
| | | | | | 5,1 | 160 | AP/05'10x0160 |
| | | | | | | 250 | AP/05'10x0250 |
| | | | | | | 400 | AP/05'10x0400 |
| | | | | | | 500 | AP/05'10x0500 |
| | | | | | 5,2 | 100 | AP/05'20x0100 |
| | | | | 125 | | AP/05'20x0125 | |
| | | | | 160 | | AP/05'20x0160 | |
| | | | | 200 | | AP/05'20x0200 | |
| 250 | AP/05'20x0250 | | | | | | |

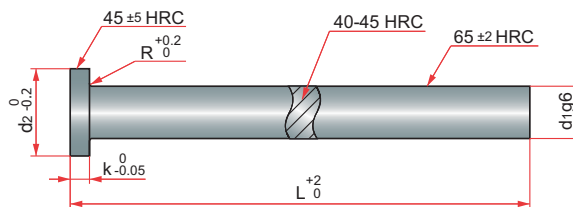

| R | k | d2 | d1 | L | REF. |
|-----|---|----|------|---------------|---------------|
| 0,3 | 3 | 8 | 5,2 | 315 | AP/05'20x0315 |
| | | | | 400 | AP/05'20x0400 |
| | | | | 500 | AP/05'20x0500 |
| | | | | 630 | AP/05'20x0630 |
| | | | | 800 | AP/05'20x0800 |
| | | | | 1000 | AP/05'20x1000 |
| | | | 5,3 | 160 | AP/05'30x0160 |
| | | | | 250 | AP/05'30x0250 |
| | | | | 400 | AP/05'30x0400 |
| | | | 5,4 | 160 | AP/05'40x0160 |
| | | | | 250 | AP/05'40x0250 |
| | | | | 400 | AP/05'40x0400 |
| | | | 5,5 | 100 | AP/05'50x0100 |
| | | | | 125 | AP/05'50x0125 |
| | | | | 160 | AP/05'50x0160 |
| | | | | 200 | AP/05'50x0200 |
| | | | | 250 | AP/05'50x0250 |
| | | | | 315 | AP/05'50x0315 |
| | | | | 400 | AP/05'50x0400 |
| | | | | 500 | AP/05'50x0500 |
| | | | | 630 | AP/05'50x0630 |
| | | | | 800 | AP/05'50x0800 |
| | | | 1000 | AP/05'50x1000 | |
| | | | 5,6 | 160 | AP/05'60x0160 |
| | | | | 250 | AP/05'60x0250 |
| | | | | 400 | AP/05'60x0400 |
| | | | 5,7 | 160 | AP/05'70x0160 |
| | | | | 250 | AP/05'70x0250 |
| | | | | 400 | AP/05'70x0400 |
| | | | 5,8 | 160 | AP/05'80x0160 |
| | | | | 250 | AP/05'80x0250 |
| | | | | 400 | AP/05'80x0400 |

| R | k | d2 | d1 | L | REF. |
|-----|-----|---------------|------|---------------|---------------|
| 0,3 | 3 | 8 | 5,9 | 160 | AP/05'90x0160 |
| | | | | 250 | AP/05'90x0250 |
| | | | | 400 | AP/05'90x0400 |
| 0,5 | 5 | 12 | 6,0 | 100 | AP/06'00x0100 |
| | | | | 125 | AP/06'00x0125 |
| | | | | 160 | AP/06'00x0160 |
| | | | | 200 | AP/06'00x0200 |
| | | | | 250 | AP/06'00x0250 |
| | | | | 315 | AP/06'00x0315 |
| | | | | 400 | AP/06'00x0400 |
| | | | | 500 | AP/06'00x0500 |
| | | | | 630 | AP/06'00x0630 |
| | | | | 800 | AP/06'00x0800 |
| | | | 1000 | AP/06'00x1000 | |
| | | | 6,1 | 160 | AP/06'10x0160 |
| | | | | 250 | AP/06'10x0250 |
| | | | | 400 | AP/06'10x0400 |
| | | | 6,2 | 100 | AP/06'20x0100 |
| | | | | 125 | AP/06'20x0125 |
| | | | | 160 | AP/06'20x0160 |
| | | | | 200 | AP/06'20x0200 |
| | | | | 250 | AP/06'20x0250 |
| | | | | 315 | AP/06'20x0315 |
| | | | | 400 | AP/06'20x0400 |
| | | | 6,3 | 250 | AP/06'30x0250 |
| | | | | 400 | AP/06'30x0400 |
| | | | | 250 | AP/06'40x0250 |
| 6,4 | 250 | AP/06'40x0250 | | | |
| | 400 | AP/06'40x0400 | | | |

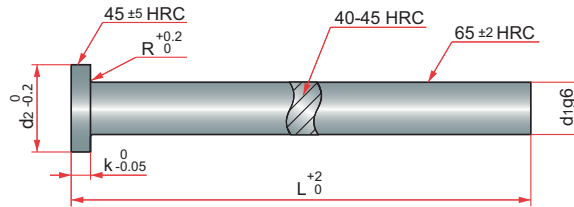

| R | k | d2 | d1 | L | REF. |
|-----|-----|---------------|-----|---------------|---------------|
| 0,5 | 5 | 12 | 6,5 | 100 | AP/06'50x0100 |
| | | | | 125 | AP/06'50x0125 |
| | | | | 160 | AP/06'50x0160 |
| | | | | 200 | AP/06'50x0200 |
| | | | | 250 | AP/06'50x0250 |
| | | | | 315 | AP/06'50x0315 |
| | | | | 400 | AP/06'50x0400 |
| | | | | 500 | AP/06'50x0500 |
| | | | | 630 | AP/06'50x0630 |
| | | | 6,6 | 160 | AP/06'60x0160 |
| | | | | 250 | AP/06'60x0250 |
| | | | | 400 | AP/06'60x0400 |
| | | | 6,7 | 160 | AP/06'70x0160 |
| | | | | 250 | AP/06'70x0250 |
| | | | | 400 | AP/06'70x0400 |
| | | | 6,8 | 160 | AP/06'80x0160 |
| | | | | 250 | AP/06'80x0250 |
| | | | | 400 | AP/06'80x0400 |
| | | | 6,9 | 160 | AP/06'90x0160 |
| | | | | 250 | AP/06'90x0250 |
| | | | | 400 | AP/06'90x0400 |
| | | | 7,0 | 100 | AP/07'00x0100 |
| | | | | 125 | AP/07'00x0125 |
| | | | | 160 | AP/07'00x0160 |
| | | | | 200 | AP/07'00x0200 |
| | | | | 250 | AP/07'00x0250 |
| | | | | 315 | AP/07'00x0315 |
| | | | | 400 | AP/07'00x0400 |
| | | | | 500 | AP/07'00x0500 |
| | | | | 630 | AP/07'00x0630 |
| | | | 800 | AP/07'00x0800 | |
| 7,1 | 160 | AP/07'10x0160 | | | |

| R | k | d2 | d1 | L | REF. | | |
|-----|---------------|----|-----|---------------|---------------|---------------|---------------|
| 0,5 | 5 | 12 | 7,1 | 250 | AP/07'10x0250 | | |
| | | | | 400 | AP/07'10x0400 | | |
| | | | 7,2 | 160 | AP/07'20x0160 | | |
| | | | | 250 | AP/07'20x0250 | | |
| | | | 400 | AP/07'20x0400 | | | |
| | | | | 7,3 | 160 | AP/07'30x0160 | |
| | | | 250 | | AP/07'30x0250 | | |
| | | | 400 | | AP/07'30x0400 | | |
| | | | 7,4 | 160 | AP/07'40x0160 | | |
| | | | | 250 | AP/07'40x0250 | | |
| | | | | 400 | AP/07'40x0400 | | |
| | | | 7,5 | 100 | AP/07'50x0100 | | |
| | | | | 125 | AP/07'50x0125 | | |
| | | | | 160 | AP/07'50x0160 | | |
| | | | | 200 | AP/07'50x0200 | | |
| | | | 250 | AP/07'50x0250 | | | |
| | | | | 14 | 7,6 | 160 | AP/07'60x0160 |
| | | | | | | 250 | AP/07'60x0250 |
| | | | 400 | | | AP/07'60x0400 | |
| | | | 7,7 | 160 | AP/07'70x0160 | | |
| | | | | 250 | AP/07'70x0250 | | |
| | | | | 400 | AP/07'70x0400 | | |
| | | | 7,8 | 160 | AP/07'80x0160 | | |
| | | | | 250 | AP/07'80x0250 | | |
| | | | | 400 | AP/07'80x0400 | | |
| | | | 7,9 | 160 | AP/07'90x0160 | | |
| | | | | 250 | AP/07'90x0250 | | |
| | | | | 400 | AP/07'90x0400 | | |
| | | | 8,0 | 100 | AP/08'00x0100 | | |
| | | | | 125 | AP/08'00x0125 | | |
| | | | | 160 | AP/08'00x0160 | | |
| 200 | AP/08'00x0200 | | | | | | |

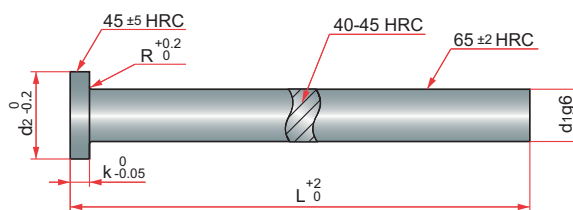

| R | k | d2 | d1 | L | REF. |
|-----|---|----|-----|---------------|---------------|
| 0,5 | 5 | 14 | 8,0 | 250 | AP/08'00x0250 |
| | | | | 315 | AP/08'00x0315 |
| | | | | 400 | AP/08'00x0400 |
| | | | | 500 | AP/08'00x0500 |
| | | | | 630 | AP/08'00x0630 |
| | | | | 800 | AP/08'00x0800 |
| | | | | 1000 | AP/08'00x1000 |
| | | | | 8,1 | 200 |
| | | | 400 | AP/08'10x0400 | |
| | | | 8,2 | 100 | AP/08'20x0100 |
| | | | | 125 | AP/08'20x0125 |
| | | | | 160 | AP/08'20x0160 |
| | | | | 200 | AP/08'20x0200 |
| | | | | 250 | AP/08'20x0250 |
| | | | | 315 | AP/08'20x0315 |
| | | | | 400 | AP/08'20x0400 |
| | | | | 500 | AP/08'20x0500 |
| | | | | 630 | AP/08'20x0630 |
| | | | | 800 | AP/08'20x0800 |
| | | | | 1000 | AP/08'20x1000 |
| | | | | 8,3 | 200 |
| | | | 400 | | AP/08'30x0400 |
| | | | 500 | | AP/08'30x0500 |
| | | | 8,4 | 200 | AP/08'40x0200 |
| | | | | 400 | AP/08'40x0400 |
| | | | | 500 | AP/08'40x0500 |
| | | | 8,5 | 100 | AP/08'50x0100 |
| | | | | 125 | AP/08'50x0125 |
| | | | | 160 | AP/08'50x0160 |
| | | | | 200 | AP/08'50x0200 |
| | | | | 250 | AP/08'50x0250 |
| | | | | 315 | AP/08'50x0315 |

| R | k | d2 | d1 | L | REF. | |
|-----|---------------|----|-----|-----|---------------|---------------|
| 0,5 | 5 | 14 | 8,5 | 400 | AP/08'50x0400 | |
| | | | | 500 | AP/08'50x0500 | |
| | | | | 630 | AP/08'50x0630 | |
| | | | 8,6 | 200 | AP/08'60x0200 | |
| | | | | 400 | AP/08'60x0400 | |
| | | | 8,7 | 200 | AP/08'70x0200 | |
| | | | | 400 | AP/08'70x0400 | |
| | | | 8,8 | 200 | AP/08'80x0200 | |
| | | | | 400 | AP/08'80x0400 | |
| | | | 8,9 | 200 | AP/08'90x0200 | |
| | | | | 400 | AP/08'90x0400 | |
| | | | | 9,0 | 100 | AP/09'00x0100 |
| | | | | | 125 | AP/09'00x0125 |
| | | | | | 160 | AP/09'00x0160 |
| | | | | | 200 | AP/09'00x0200 |
| | | | 9,1 | 250 | AP/09'00x0250 | |
| | | | | 315 | AP/09'00x0315 | |
| | | | | 400 | AP/09'00x0400 | |
| | | | | 500 | AP/09'00x0500 | |
| | | | | 630 | AP/09'00x0630 | |
| | | | | 9,1 | 200 | AP/09'10x0200 |
| | | | 400 | | AP/09'10x0400 | |
| | | | 9,2 | 200 | AP/09'20x0200 | |
| | | | | 400 | AP/09'20x0400 | |
| | | | 9,3 | 200 | AP/09'30x0200 | |
| | | | | 400 | AP/09'30x0400 | |
| | | | 9,4 | 200 | AP/09'40x0200 | |
| | | | | 400 | AP/09'40x0400 | |
| | | | 9,5 | 100 | AP/09'50x0100 | |
| | | | | 125 | AP/09'50x0125 | |
| 160 | AP/09'50x0160 | | | | | |
| 200 | AP/09'50x0200 | | | | | |

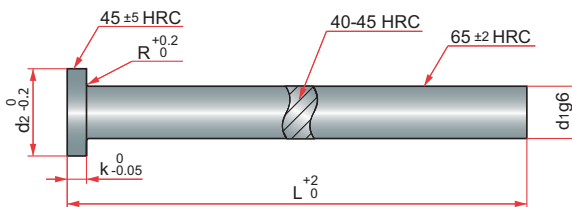

| R | k | d2 | d1 | L | REF. | |
|-----|---------------|------|---------------|---------------|---------------|---------------|
| 0,5 | 5 | 14 | 9,5 | 250 | AP/09'50x0250 | |
| | | | | 315 | AP/09'50x0315 | |
| | | | | 400 | AP/09'50x0400 | |
| | | | | 500 | AP/09'50x0500 | |
| | | | | 630 | AP/09'50x0630 | |
| | | | 16 | 9,6 | 200 | AP/09'60x0200 |
| | | | | | 400 | AP/09'60x0400 |
| | | | | 9,7 | 200 | AP/09'70x0200 |
| | | | | | 400 | AP/09'70x0400 |
| | | | | 9,8 | 200 | AP/09'80x0200 |
| | | 400 | | | AP/09'80x0400 | |
| | | 9,9 | | 200 | AP/09'90x0200 | |
| | | | | 400 | AP/09'90x0400 | |
| | | 10,0 | | 100 | AP/10'00x0100 | |
| | | | | 125 | AP/10'00x0125 | |
| | | | 160 | AP/10'00x0160 | | |
| | | | 200 | AP/10'00x0200 | | |
| | | | 250 | AP/10'00x0250 | | |
| | | | 315 | AP/10'00x0315 | | |
| | | | 400 | AP/10'00x0400 | | |
| | | | 500 | AP/10'00x0500 | | |
| | | | 630 | AP/10'00x0630 | | |
| | | | 800 | AP/10'00x0800 | | |
| | | 1000 | AP/10'00x1000 | | | |
| | | 10,1 | 200 | AP/10'10x0200 | | |
| | | | 400 | AP/10'10x0400 | | |
| | | 10,2 | 100 | AP/10'20x0100 | | |
| | | | 125 | AP/10'20x0125 | | |
| 160 | AP/10'20x0160 | | | | | |
| 200 | AP/10'20x0200 | | | | | |
| 250 | AP/10'20x0250 | | | | | |
| 315 | AP/10'20x0315 | | | | | |

| R | k | d2 | d1 | L | REF. | | | |
|-----|---------------|----|------|------|---------------|---------------|-----|---------------|
| 0,5 | 5 | 16 | 10,2 | 400 | AP/10'20x0400 | | | |
| | | | | 500 | AP/10'20x0500 | | | |
| | | | | 630 | AP/10'20x0630 | | | |
| | | | 10,5 | 100 | AP/10'50x0100 | | | |
| | | | | 125 | AP/10'50x0125 | | | |
| | | | | 160 | AP/10'50x0160 | | | |
| | | | | 200 | AP/10'50x0200 | | | |
| | | | | 250 | AP/10'50x0250 | | | |
| | | | | 315 | AP/10'50x0315 | | | |
| | | | | 400 | AP/10'50x0400 | | | |
| | | | | 500 | AP/10'50x0500 | | | |
| | | | | 630 | AP/10'50x0630 | | | |
| | | | | 800 | AP/10'50x0800 | | | |
| | | | | 11,0 | 100 | AP/11'00x0100 | | |
| | | | | | 125 | AP/11'00x0125 | | |
| | | | | | 160 | AP/11'00x0160 | | |
| | | | | | 200 | AP/11'00x0200 | | |
| | | | | | 250 | AP/11'00x0250 | | |
| | | | | | 315 | AP/11'00x0315 | | |
| | | | | | 400 | AP/11'00x0400 | | |
| | | | 500 | | AP/11'00x0500 | | | |
| | | | 630 | | AP/11'00x0630 | | | |
| | | | 800 | | AP/11'00x0800 | | | |
| | | | 11,5 | 200 | AP/11'50x0200 | | | |
| | | | | 400 | AP/11'50x0400 | | | |
| | | | | 630 | AP/11'50x0630 | | | |
| | | | 0,8 | 7 | 18 | 12,0 | 100 | AP/12'00x0100 |
| | | | | | | | 125 | AP/12'00x0125 |
| | | | | | | | 160 | AP/12'00x0160 |
| | | | | | | | 200 | AP/12'00x0200 |
| 250 | AP/12'00x0250 | | | | | | | |
| 315 | AP/12'00x0315 | | | | | | | |
| 400 | AP/12'00x0400 | | | | | | | |

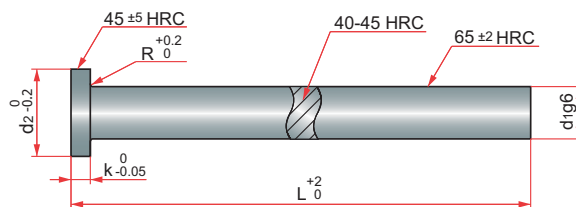

| R | k | d2 | d1 | L | REF. |
|-----|---|------|------|---------------|---------------|
| 0,8 | 7 | 18 | 12,0 | 500 | AP/12'00x0500 |
| | | | | 630 | AP/12'00x0630 |
| | | | | 800 | AP/12'00x0800 |
| | | | | 1000 | AP/12'00x1000 |
| | | | 12,2 | 100 | AP/12'20x0100 |
| | | | | 125 | AP/12'20x0125 |
| | | | | 160 | AP/12'20x0160 |
| | | | | 200 | AP/12'20x0200 |
| | | | | 250 | AP/12'20x0250 |
| | | | | 315 | AP/12'20x0315 |
| | | | | 400 | AP/12'20x0400 |
| | | | | 500 | AP/12'20x0500 |
| | | | 12,5 | 630 | AP/12'20x0630 |
| | | | | 100 | AP/12'50x0100 |
| | | | | 125 | AP/12'50x0125 |
| | | | | 160 | AP/12'50x0160 |
| | | 200 | | AP/12'50x0200 | |
| | | 250 | | AP/12'50x0250 | |
| | | 315 | | AP/12'50x0315 | |
| | | 400 | | AP/12'50x0400 | |
| | | 13,0 | 500 | AP/12'50x0500 | |
| | | | 630 | AP/12'50x0630 | |
| | | | 100 | AP/13'00x0100 | |
| | | | 125 | AP/13'00x0125 | |
| | | | 160 | AP/13'00x0160 | |
| | | | 200 | AP/13'00x0200 | |
| | | | 250 | AP/13'00x0250 | |
| | | | 315 | AP/13'00x0315 | |
| | | 22 | 13,5 | 400 | AP/13'00x0400 |
| | | | | 630 | AP/13'00x0630 |
| | | | | 250 | AP/13'50x0250 |
| | | | | 400 | AP/13'50x0400 |

| R | k | d2 | d1 | L | REF. | |
|-----|---|----|------|------|---------------|---------------|
| 0,8 | 7 | 22 | 14,0 | 630 | AP/13'50x0630 | |
| | | | | 100 | AP/14'00x0100 | |
| | | | | 125 | AP/14'00x0125 | |
| | | | | 160 | AP/14'00x0160 | |
| | | | | 200 | AP/14'00x0200 | |
| | | | | 250 | AP/14'00x0250 | |
| | | | | 315 | AP/14'00x0315 | |
| | | | | 400 | AP/14'00x0400 | |
| | | | | 500 | AP/14'00x0500 | |
| | | | | 630 | AP/14'00x0630 | |
| | | | | 800 | AP/14'00x0800 | |
| | | | | 1000 | AP/14'00x1000 | |
| | | | | 14,5 | 250 | AP/14'50x0250 |
| | | | | | 400 | AP/14'50x0400 |
| | | | | | 630 | AP/14'50x0630 |
| | | | | 15,0 | 100 | AP/15'00x0100 |
| | | | 125 | | AP/15'00x0125 | |
| | | | 160 | | AP/15'00x0160 | |
| | | | 200 | | AP/15'00x0200 | |
| | | | 15,0 | 250 | AP/15'00x0250 | |
| | | | | 400 | AP/15'00x0400 | |
| | | | | 100 | AP/16'00x0100 | |
| | | | | 125 | AP/16'00x0125 | |
| | | | 16,0 | 160 | AP/16'00x0160 | |
| | | | | 200 | AP/16'00x0200 | |
| | | | | 250 | AP/16'00x0250 | |
| | | | | 315 | AP/16'00x0315 | |
| | | | 16,0 | 400 | AP/16'00x0400 | |
| | | | | 500 | AP/16'00x0500 | |
| | | | | 630 | AP/16'00x0630 | |
| | | | | 800 | AP/16'00x0800 | |
| | | | 16,0 | 1000 | AP/16'00x1000 | |

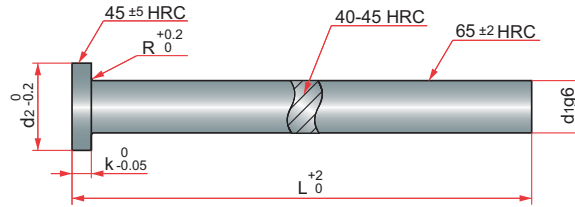

| R | k | d2 | d1 | L | REF. | |
|------|---------------|------|------|---------------|---------------|---------------|
| 0,8 | 7 | 22 | 16,2 | 200 | AP/16'20x0200 | |
| | | | | 400 | AP/16'20x0400 | |
| | | 16,5 | 200 | AP/16'50x0200 | | |
| | | | 400 | AP/16'50x0400 | | |
| | | 24 | 18,0 | 100 | AP/18'00x0100 | |
| | | | | 125 | AP/18'00x0125 | |
| | 160 | | | AP/18'00x0160 | | |
| | 200 | | | AP/18'00x0200 | | |
| | 250 | | | AP/18'00x0250 | | |
| | 315 | | | AP/18'00x0315 | | |
| | 1 | 8 | 26 | 20,0 | 100 | AP/18'00x0400 |
| | | | | | 500 | AP/18'00x0500 |
| | | | | | 630 | AP/18'00x0630 |
| | | | | | 800 | AP/18'00x0800 |
| 1000 | | | | | AP/18'00X1000 | |
| 100 | | | | | AP/20'00x0100 | |
| 125 | | | | | AP/20'00x0125 | |
| 160 | | | | | AP/20'00x0160 | |
| 200 | AP/20'00x0200 | | | | | |
| 250 | AP/20'00x0250 | | | | | |
| 315 | AP/20'00x0315 | | | | | |
| 400 | AP/20'00x0400 | | | | | |
| 500 | AP/20'00x0500 | | | | | |
| 630 | AP/20'00x0630 | | | | | |

| R | k | d2 | d1 | L | REF. |
|------|---------------|------|---------------|---------------|---------------|
| 1 | 8 | 26 | 20,0 | 800 | AP/20'00x0800 |
| | | | | 1000 | AP/20'00X1000 |
| | | 20,5 | 250 | AP/20'50x0250 | |
| | | | 400 | AP/20'50x0400 | |
| | | 28 | 22,0 | 250 | AP/22'00x0250 |
| | | | | 400 | AP/22'00x0400 |
| | 10 | 32 | 25,0 | 160 | AP/25'00x0160 |
| | | | | 200 | AP/25'00x0200 |
| | | | 25,0 | 250 | AP/25'00x0250 |
| | | | | 315 | AP/25'00x0315 |
| | | | 400 | AP/25'00x0400 | |
| | | | 500 | AP/25'00x0500 | |
| | | 630 | AP/25'00x0630 | | |
| | | 800 | AP/25'00x0800 | | |
| | | 1000 | AP/25'00X1000 | | |
| | | 40 | 32,0 | 200 | AP/32'00x0200 |
| | | | | 250 | AP/32'00x0250 |
| | | | | 315 | AP/32'00x0315 |
| 400 | AP/32'00x0400 | | | | |
| 500 | AP/32'00x0500 | | | | |
| 630 | AP/32'00x0630 | | | | |
| 800 | AP/32'00x0800 | | | | |
| 1000 | AP/32'00X1000 | | | | |